

1

IMPORTANT: Read This FIRST!

On the underside of part C03/C16 and C07/C15 an embossed letter "A" and "B" is engraved respectively. Assembling pieces with the same letter (that is A/A or B/B) will allow you to build a straight wall section. Assembling pieces with two different letters (that is A/B) will allow you to build a corner wall section.

It is best to **test-fit** the two pieces before gluing the two parts together to form either a straight or corner wall.

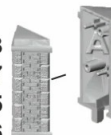

C03
C07
C15
C16

Please use the diagram on the right for references.

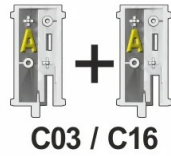

OR

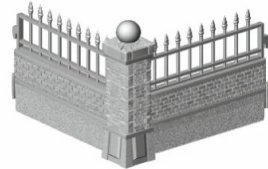
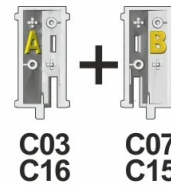
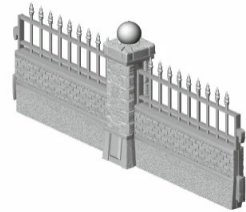
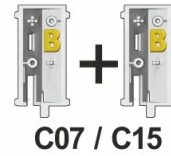

2

C18 / C19

C05 / C09

Pillar Assembly

1

C04 / C17



3

Brick Wall Assembly

C02 / C08
C12 / C22

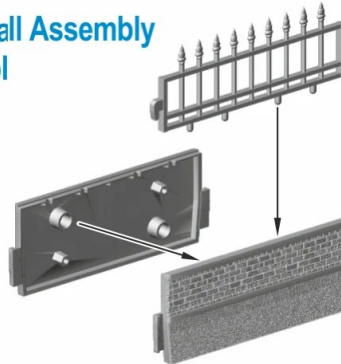

C06 / C14

C02 / C08
C12 / C22

4

Iron Gate Assembly

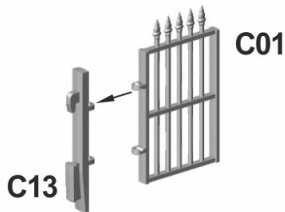

5

Choices & More Choices...

Based on your own requirement, using the pillar as the center piece, you can connect wall or gate pieces to it.

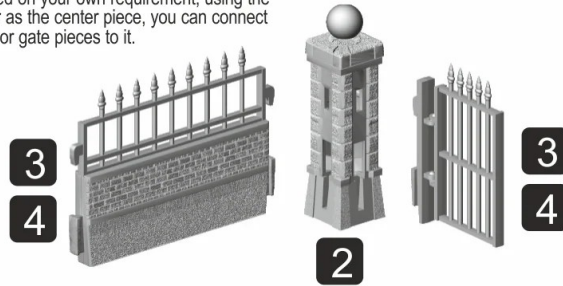

6

Finishing the Assembly

C10 / C11
C20 / C21
can use any one

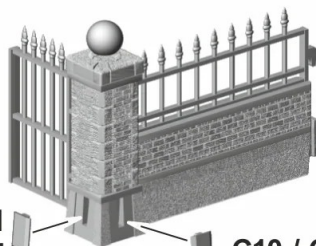

C10 / C11
C20 / C21
can use any one

C10 / C11
C20 / C21
can use any one

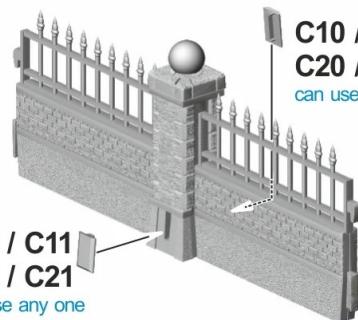

C10 / C11
C20 / C21
can use any one